

lualdi®

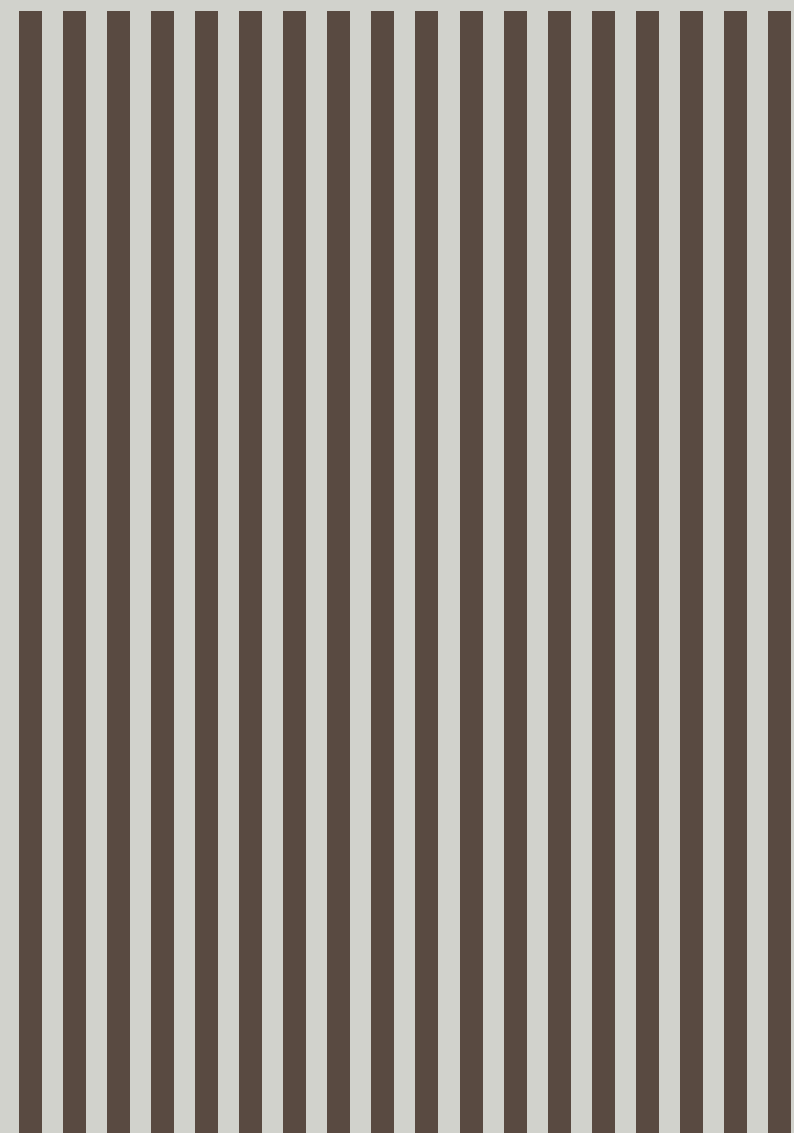

Index
— —

2
Koan
— —

16
Matrix
— —

29
Disegni tecnici /
Technical drawings
— —

34
Finiture / Finishes
— —

Koan —

Unendo la luce di vetro e alluminio al calore del legno, Koan rappresenta la perfetta coesione tra tecnologia e tradizione. La combinazione di listelli verticali, che si alternano su lunghezze variabili, sottolinea il valore prezioso del pannello vetrato in grado di offrire un ritaglio scenografico dello spazio oltre la porta.

Design Kokaistudios

Koan combines the brightness of precious glass and metal finishes with the warmth of wood, creating a perfect cohesion of technology and tradition. The combination

of vertical slats highlights the value of the glazed panel, offering a scenographic view of the space beyond the door.
Design Kokaistudios





Koan, con listelli in rovere moka,
profilo nero e vetro bronzo trasparente,
permette di realizzare spazi comunicanti
fluidi e flessibili.

Koan, with Moka oak slats, black edge
profile and transparent bronze glass,
allows the creation of connected spaces
that are both fluid and flexible.

Koan__6





Riflessi caldi per questa composizione a due ante scorrevoli, con listelli in rovere sabbia, profilo bronzo e vetro grigio trasparente.

Warm reflections for the composition with two sliding doors, with sand oak slats, bronze edge profile and transparent grey glass.

Koan__10



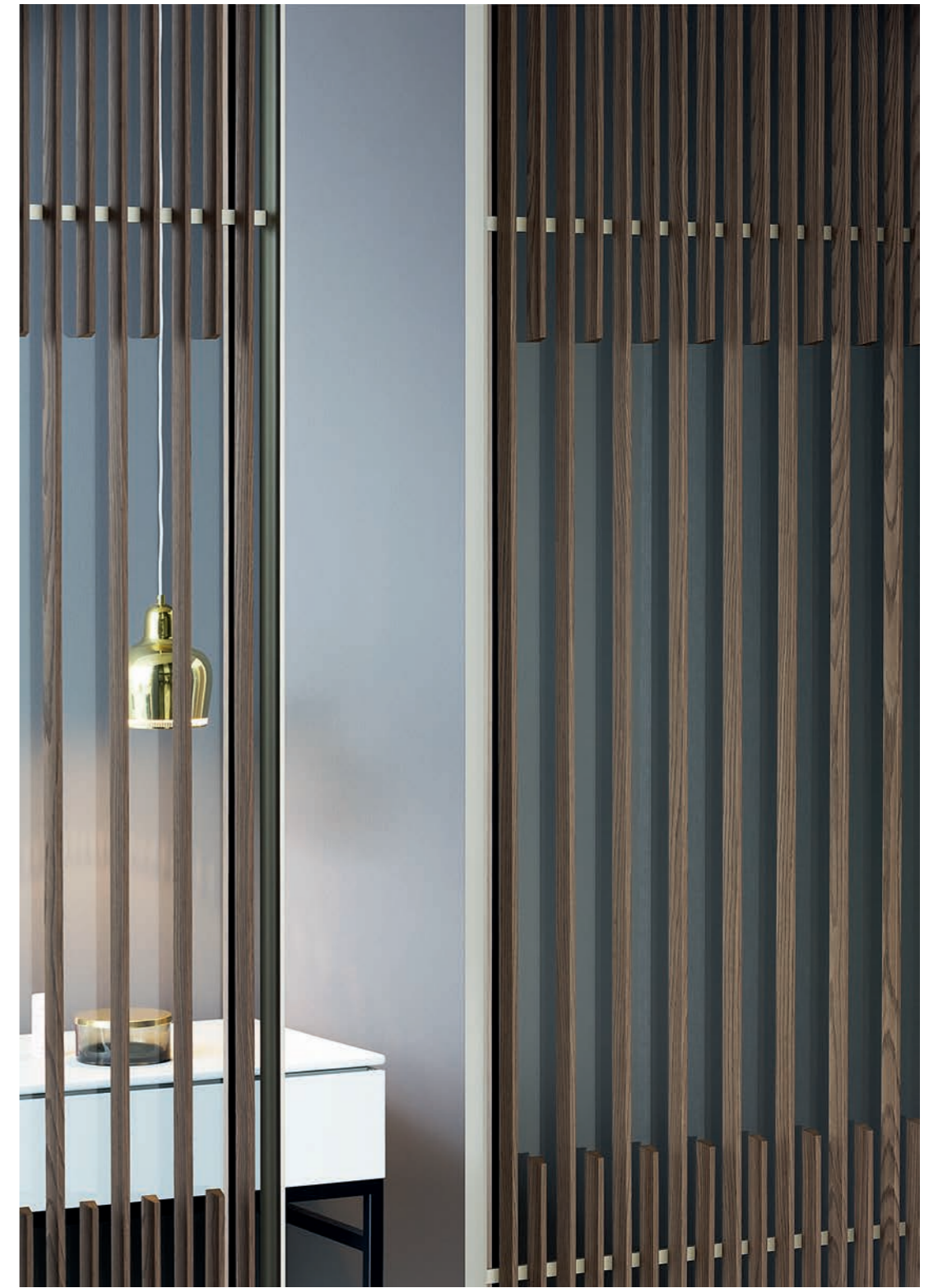



Riprendendo il leitmotiv dei listelli, la maniglia diviene un elemento verticale decorativo per un effetto di grande impatto visivo.

Evoking the leitmotiv of slats, the handle becomes a decorative vertical element to great visual effect.

Koan__14



Matrix —

Sofisticata nell'uso tecnologico dei materiali, Matrix è la nuova finitura creata dall'accostamento di tre diversi intagli. La solida purezza del legno massello, unita ad una lavorazione altamente raffinata, è esaltata dai giochi grafici di linee ed ombre creati dai diversi pattern. Matrix conferisce dinamismo ai prodotti Lualdi rendendoli elementi architettonici flessibili, innovativi e di grande impatto decorativo.

Design Piero Lissoni

Sophisticated and technological use of materials, Matrix is the new finish created by the combination of three different carvings. The purity of solid wood, combined is enhanced by the graphic play of lines and shades,

created by unique patterns. Matrix confers dynamism to products, which become flexible and innovative architectural elements possessing great decorative impact.
Design Piero Lissoni



Il calore e la vita del legno vengono resi palpabili dal volume nitido dell'anta pivotante, i cui dettagli scolpiscono delicatamente la parete.

The warmth and life of wood are made palpable by the clear-cut volume of this pivoting door, whose details delicately chisel the wall.

Matrix__18





Matrix_20



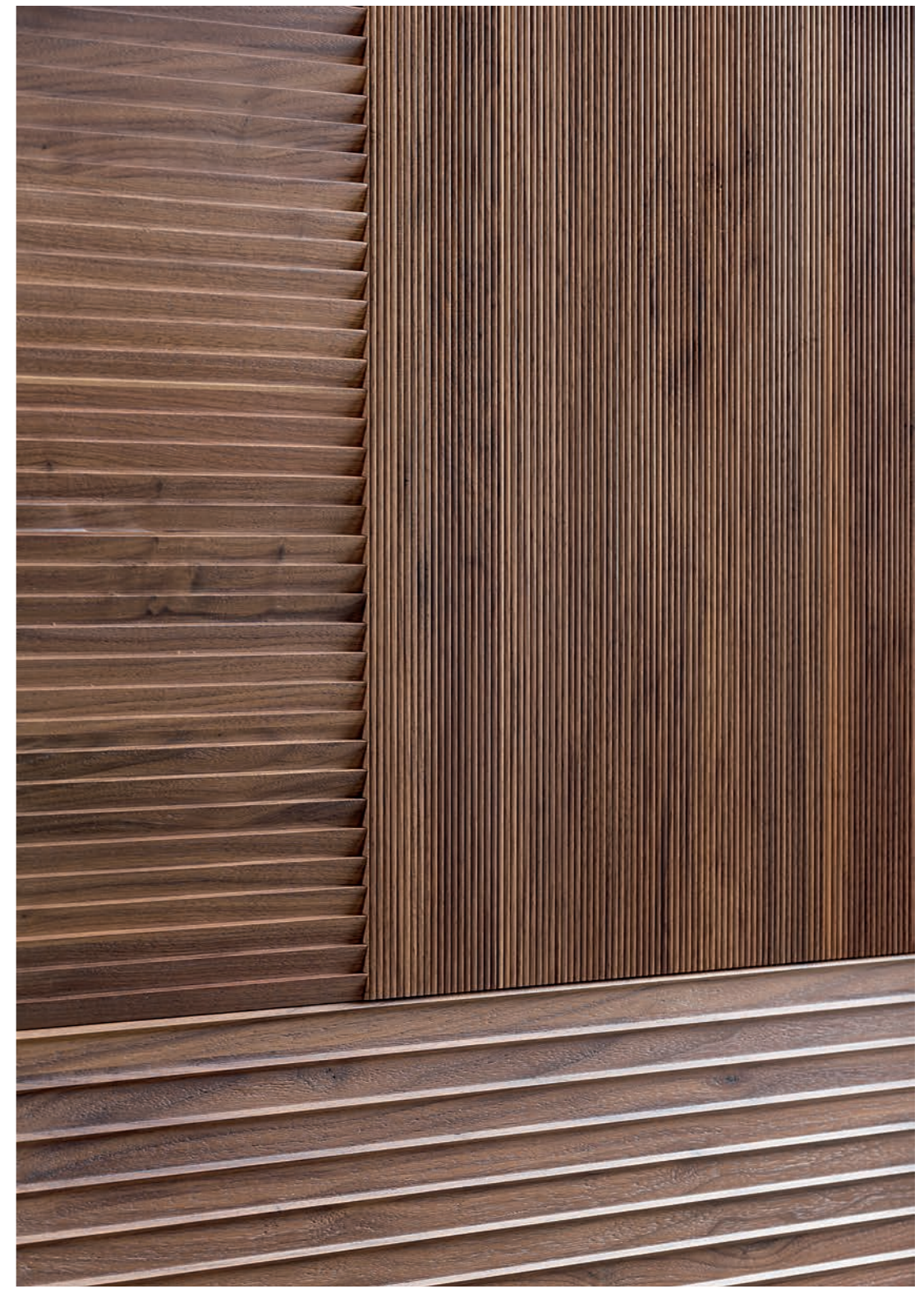



Una bellezza materica e naturale
per l'anta scorrevole in finitura Matrix,
sottolineata dall'armonia della
pannellatura liscia in noce canaletto.

A materic and natural beauty for the
sliding panel in Matrix finish, accented
by the harmony of the wall cladding
in Canaletto walnut.

Matrix_26



Disegni tecnici
Technical drawings

—

Finiture
Finishes

—

Koan

Koan

Anta di spessore 50 mm, configurabile in diversi sistemi di pannelli scorrevoli e fissi, disponibile con vetro di sicurezza spessore 6 mm, profilo in alluminio e listelli in legno. Binario con sistema decelerante e carrello con meccanismo di regolazione in altezza.

Sliding system door with aluminium edges 50 mm thick, tempered glass 6 mm thick and wood slats with trapezoidal section. The system is available with fix and sliding panels. Track with shock absorber system and trolley with height adjustment mechanism.

binario singolo / single track

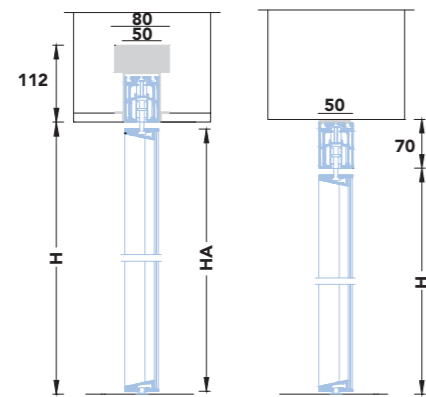

L
luce netta / opening width
600-1400 mm 23 5/8" - 55 1/2"

H
altezza netta / opening height
max 3000 mm 118 1/4"

LA
misura anta / panel sizes
L + 14 mm

HA
misura anta / panel sizes
L - 14 mm

anta singola esterno muro / external single door leaf

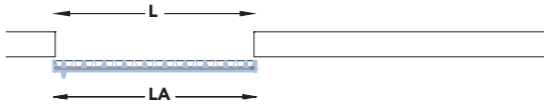

due ante esterno muro / external double door leaves

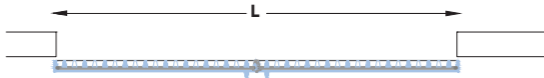

binario doppio / double track

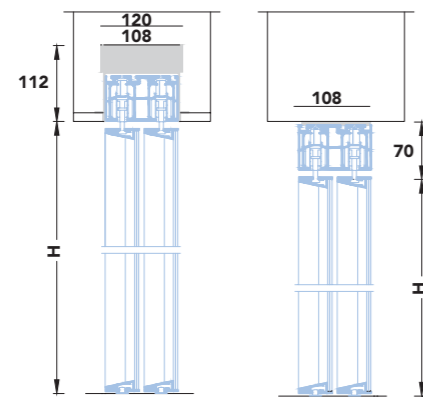

due ante interno muro / internal double door leaves



quattro ante interno muro / internal four door leaves



esempio configurazione Koan / example Koan layout

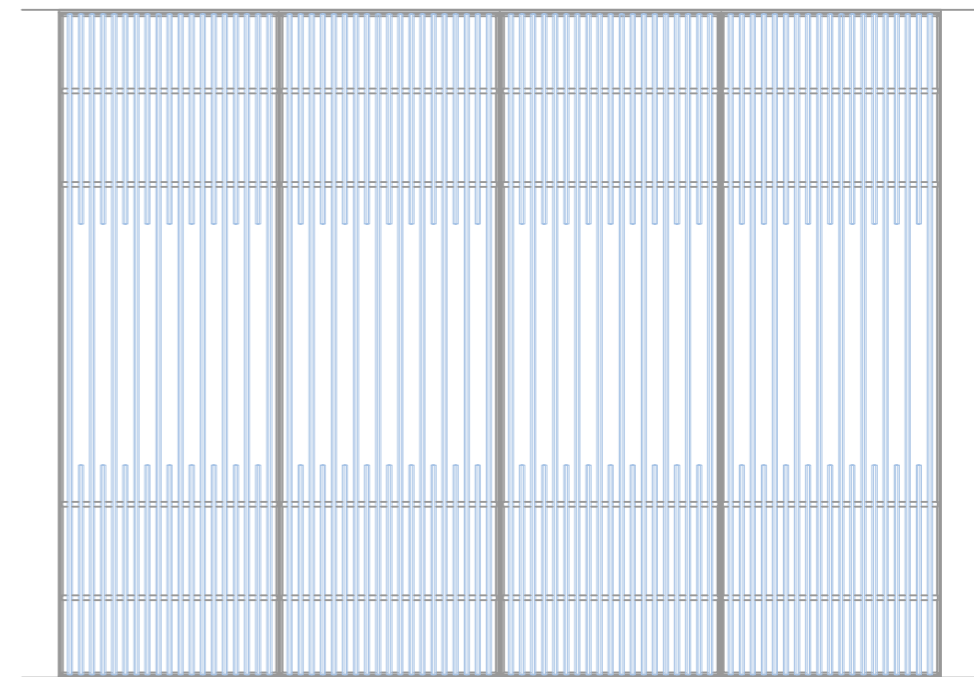

lato A / side A

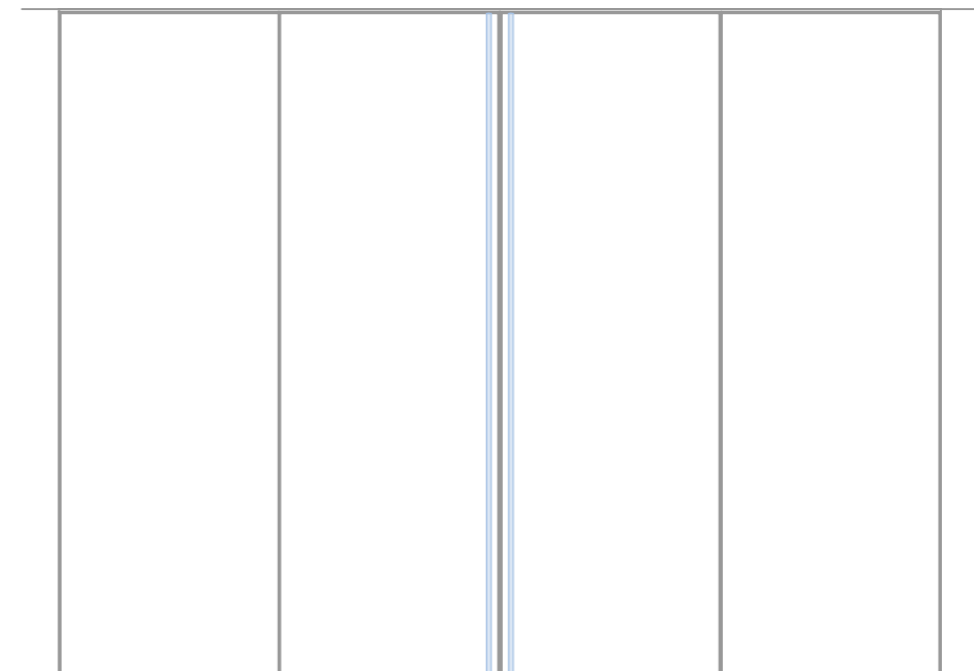

lato B / side B

Matrix

Matrix

Battenti e scorrevoli: pannello in legno massello composto da tre diversi rilievi - A, B e C - accostati come da configurazione. Applicabile, solo a un lato, a: Rasomuro 55s, Compass 55 e ante scorrevoli con 50 mm di spessore.
Boiserie: pannello in legno massello disponibile con un solo rilievo a scelta tra A, B o C.

Swing and sliding doors: solid wood panel composed of three different millings - A, B and C. Layout available, one side only, for: Rasomuro 55s, Compass 55 and sliding doors with 50 mm thick. Wall cladding: solid wood panel available in one milling only - A, B, or C.

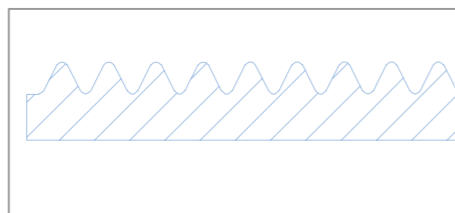

tipo A / type A

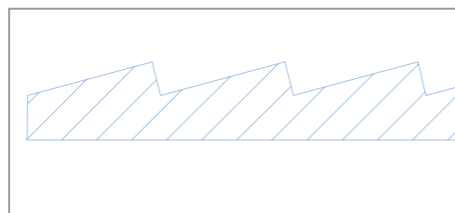

tipo B / type B

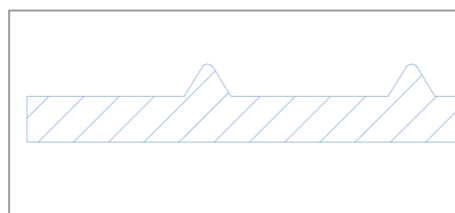
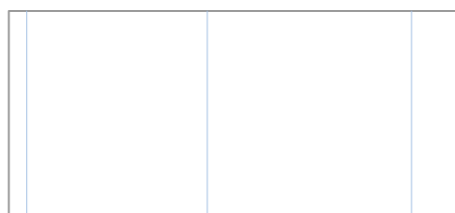

tipo C / type C

configurazione Matrix per Rasomuro 55s / Compass 55 / Matrix layout for Rasomuro 55s / Compass 55

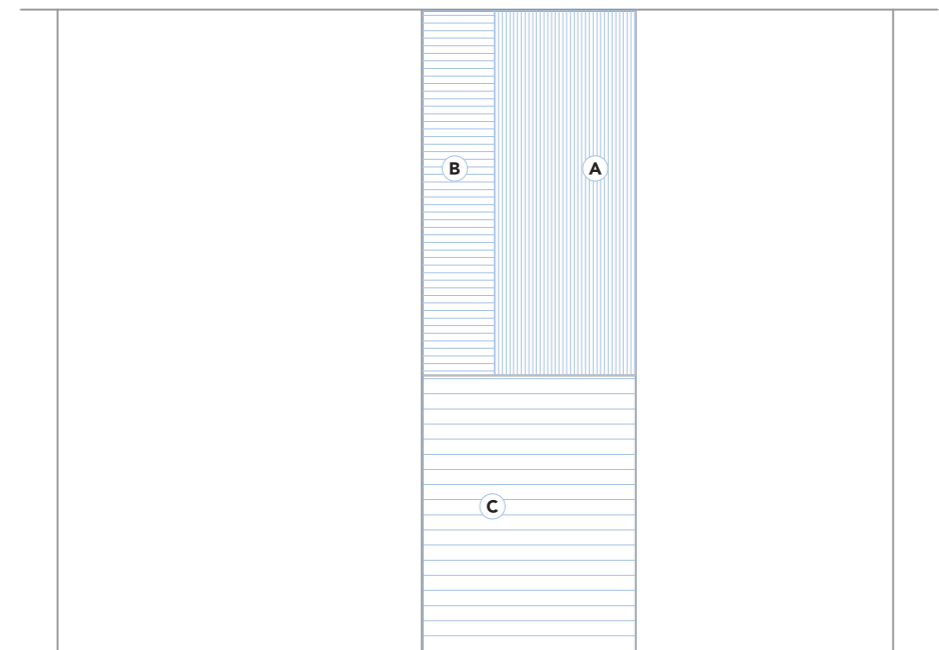

configurazione Matrix per anta scorrevole / Matrix layout for sliding doors

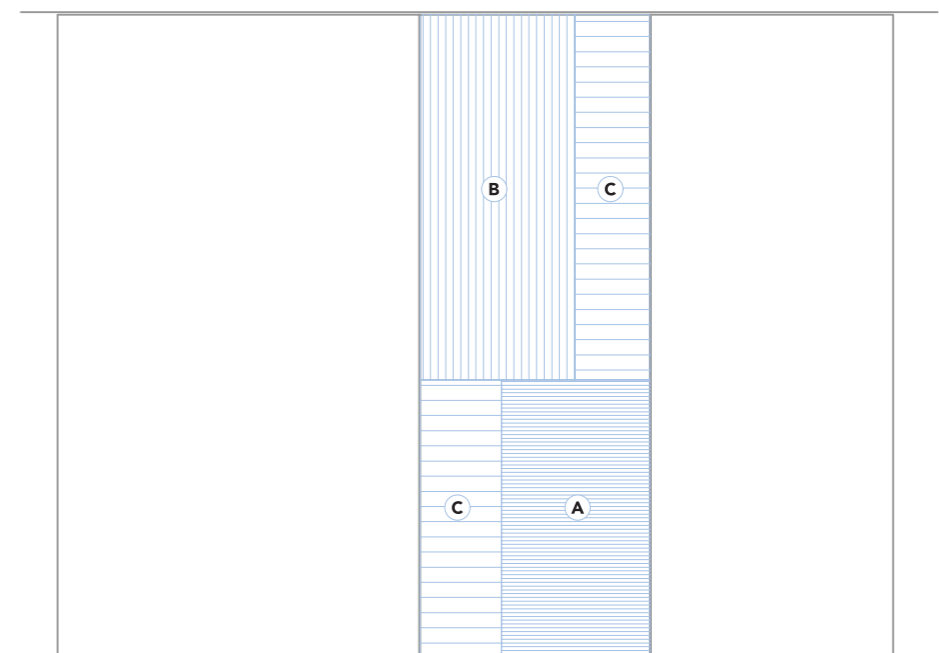

Vetri
Glasses



Trasparente Extrachiaro
Transparent Extraclear



Satinato Extrachiaro
Satin Extraclear



Extrachiaro Riflettente
Reflective Extraclear



Grigio Trasparente
Transparent Grey



Grigio Satinato
Satin Grey



Grigio Riflettente
Reflective Grey



Extrachiaro Opalino
Opalin Extraclear



Bronzo Trasparente
Transparent Bronze



Bronzo Satinato
Satin Bronze



Bronzo Riflettente
Reflective Bronze

Profili
Profiles



Alluminio Naturale
Natural Aluminium



Brill Spazzolato
Brushed Brill



Nero
Black



Bronzo
Bronze

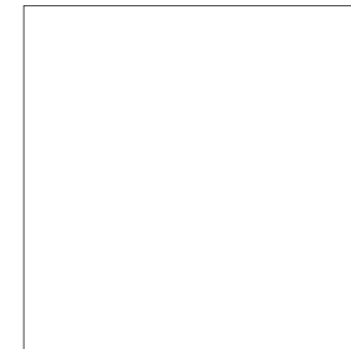

Bianco
White

Legni
Woods



Rovere Naturale
Natural Oak



Rovere Moka
Moka Oak



Noce Canaletto
Canaletto Walnut

Lualdi Spa

Via Kennedy
20010 Marcallo con Casone (MI)
T. +39 02 9789248
F. +39 02 97289463
www.lualdi.com
info@lualdi.com

Showroom

Milano

Foro Buonaparte 74
20121 Milano
T. +39 02 8052445
F. +30 02 8052251
showroom@lualdi.com

Miami

Lualdi Inc.
318 NE 80th Terrace
FL 33138
T. +1 305 576 4333
F. +1 305 576 7413
infomiami@lualdi.us

New York

110 Greene Street
Suite 306, New York
NY 10012
T. +212 334 4544
F. +212 334 4618
infony@lualdi.us

Thanks to:

Almerich
Amaaro!
Amini
Aytm
Carre' d'artistes Milano
CC Tapis
Ceramica Cielo
Co.arch Studio
Edb Design
Edizioni Design
Fantini Rubinetti
Francesca Verardo
Gaia Roma
Gallotti & Radice
Ilaria Marelli
Karpeta
Lema
London Art
Mani Ceramics
Meridiani
Nemo Lighting
Niki Jones
Pietro Russo
San Giacomo
Texture
Venicem
Vito Nesta per Les-Ottomans e Fratelli Majello
Vitra.com distribuita in Italia da Molteni&C E Unifor.
Zanotta

a.d. Graph.x

foto Giuseppe Brancato
styling Alessandra Salaris

retouching, pre press A. De Pedrini
stampa Nava Press 2018

I colori e le finiture, le illustrazioni e le descrizioni del presente catalogo sono a titolo indicativo. Lualdi spa si riserva il diritto di apportare, anche senza preavviso, modifiche di carattere tecnico e produttivo.

The colours, finishes, illustrations and descriptions in this catalogue are provided solely by way of example. Lualdi spa reserves the right to make technical and design changes without prior notice.

