



SWING TABLET

THE ITALIAN STYLE DOOR

Dierre
YOUR HOME, YOUR LIFE

THE ITALIAN STYLE DOOR

Dierre

YOUR HOME, YOUR LIFE

Porte di sicurezza	<i>Security doors</i>
Rivestimenti per porte di sicurezza	<i>Security doors panelling</i>
Serramenti per esterni	<i>External doors</i>
Controtelai per chiusure a scomparsa	<i>Subframes for sliding-away doors</i>
Porte per interni - Mood Wood	<i>Internal doors - Mood Wood</i>
Porte tagliafuoco per interni in legno	<i>Internal wooden fire doors</i>
Porte tagliafuoco	<i>Fire doors</i>
Porte multifunzione	<i>Multipurpose doors</i>
Portoni per garage basculanti e sezionali	<i>Up & over and sectional garage doors</i>
Casseforti e armadi	<i>Safes and lockers</i>

DIERRE SPA – STRADA STATALE PER CHIERI 66/15

14019 VILLANOVA D'ASTI (AT) - ITALY

TEL +39 0141.949411 - FAX +39 0141.946427 info@dierre.it

w w w . d i e r r e . c o m

seguici su      



L'ambientazione ed il contesto estetico in cui le immagini delle porte sono state inserite sono puramente suggestivi e, pertanto, alcuni elementi presenti nelle foto (quali a titolo esemplificativo cornici, coprifili, accessori) potrebbero non essere disponibili o dover essere oggetto di specifica richiesta in sede di ordine.

The setting and aesthetic context the images of the doors have been inserted in are merely inspiring and, therefore, some items in the pictures (such as for example cornices, cover moulds, accessories) may not be available or be the subject of a specific request when ordering.

Soul contemporaneo
Contemporary Soul

4

SWING TABLET	1 1 ^{plus}	10
SWING TABLET	3 3 ^{plus}	12
SWING TABLET	4 4 ^{plus}	14
SWING TABLET	8 8 ^{plus}	16

La sicurezza Swing
Security by Swing

18

Lo stile Swing
Style by Swing

22

Schede tecniche
Technical Sheets

30



PORTA TRADIZIONALE
TRADITIONAL DOOR

SWING
TABLET



SWING TABLET

Soul contemporaneo *Contemporary Soul*

Con Dierre, le idee crescono e nasce Swing Tablet, sintesi originale di design, funzionalità, sicurezza. Elegante, essenziale, giovane, Swing Tablet è una porta blindata con cerniere a scomparsa e apertura a 110°.

Dedicata alle abitazioni in cui tutte le superfici, anche quelle a ridosso dell'ingresso, vengono ottimizzate e utilizzate con intelligenza, la nuova porta interpreta tendenze e stile contemporaneo, con carattere e ricercatezza minimal.

Ideas grow with Dierre even when spaces are reduced. Swing Tablet is conceived, original blend of design, functionality, safety. Trendy, essential, young, Swing Tablet is a security door with concealed hinges and 110° opening.

Dedicated to homes where all the surfaces, even those close to the entrance, are optimized and cleverly used, the new door interprets contemporary trends and style, through a strong character and minimal-style refinement.

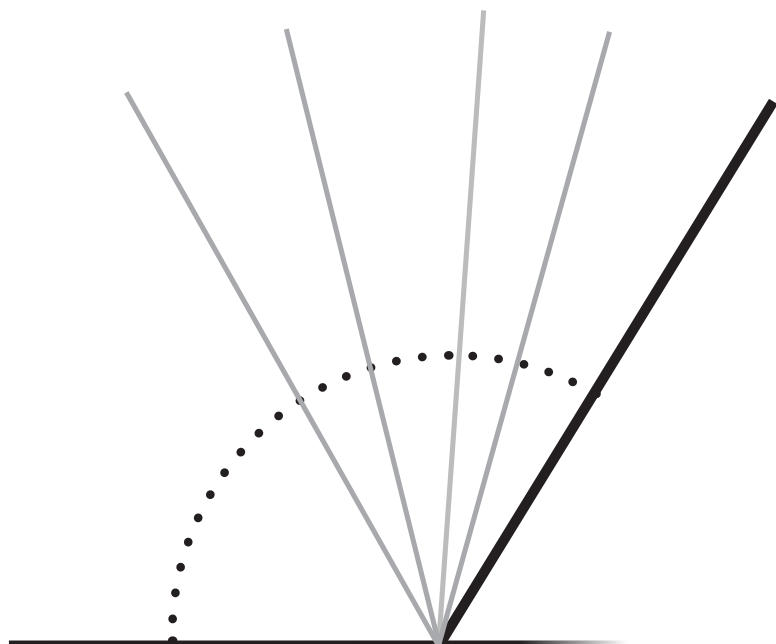

APERTURA 110°
110° OPENING



**FERMO PORTA
ANTI-TORSIONE TELAIO**
*FRAME TWIST-PREVENTION
DOOR STOP*



**CERNIERA
A SCOMPARSA**
CONCEALED HINGE



ROSTRO SWING
SWING GRIP

Una porta intelligente

A smart door

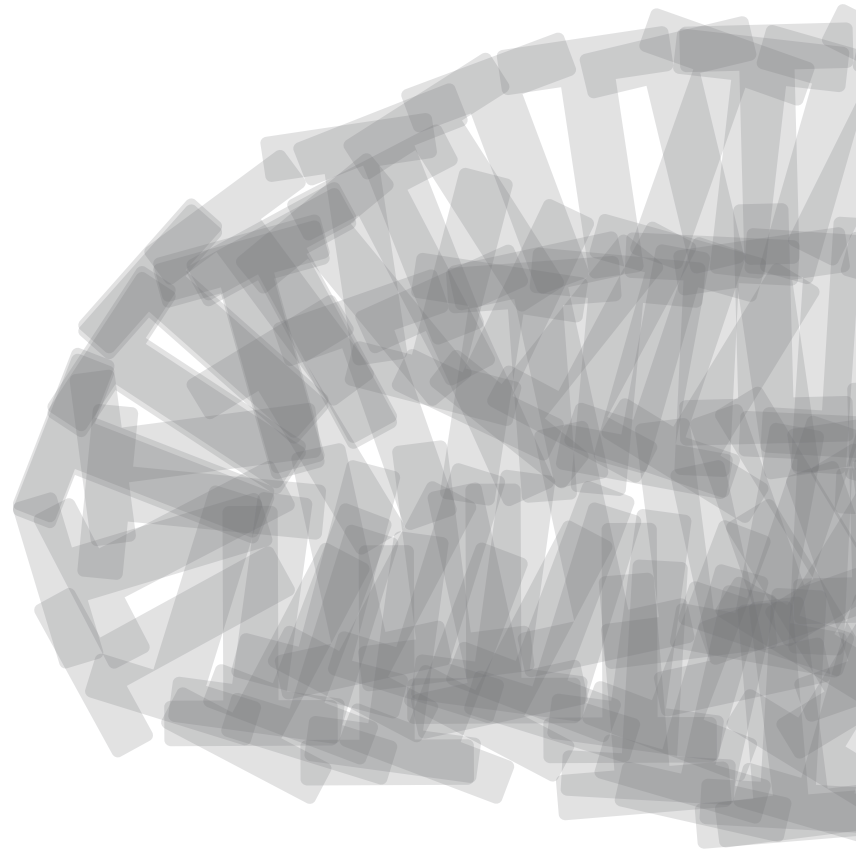

Intelligente, facile, sicura,

Swing Tablet è il risultato di una tecnologia esclusiva, che consente un mix di ottime prestazioni, in uno spessore ridotto e a un costo contenuto. La particolare struttura interna alla scocca a doppia lamiera garantisce:

3**Classe 3
antiefrazione****Trasmittanza
termica di serie
1,3 w/m²K**

(con pannelli 7+7 mm,
per uno spessore dell'anta
di soli 63 mm)

**40 dB di
isolamento
acustico***

*A richiesta 42 dB

Smart, easy, secure, Swing Tablet is the result of an exclusive technology, allowing a blend of superior performance, with reduced thickness in reduced and with reduced costs. The peculiar structure inside the double sheet metal body guarantees:

- **Burglar resistance in Class 3**
- **Standard thermal transmittance 1.3 w/m²K (with panels 7+7 mm, for a thickness of the leaf of only 63 mm)**
- **40 dB of acoustic insulation***

**On request 42 dB*

Disponibile a battente singolo, solo a misure standard
Available in single leaf, only in standard sizes

I quattro modelli Swing Tablet sono proposti in versione standard e in versione Plus.
La versione standard è con carenatura a graffa (ovvero una carenatura avvolgente che ferma il pannello interno ed esterno della porta). La versione Plus prevede la cornice fermapannello Fast Grip, brevettata da Dierre, che, oltre a consentire un rapido montaggio e smontaggio del pannello interno per eventuali manutenzioni o sostituzioni, rappresenta una soluzione esteticamente più discreta.

*The four Swing Tablet models are offered in the standard and Plus version.
The standard version is with clip-on trim (being an enveloping trim that stops the inner and outer panels of the door). The Plus version includes the Dierre patented Fast Grip panel-holding cornice, which, in addition to allowing quick assembly and disassembly of the inner panel for maintenance or replacements, gives better aesthetic features.*

Fast-Grip®



SWING
TABLET



CARENATURA A GRAFFA
CLIP ON TRIM

SWING
TABLET *plus*



CORNICE FERMAPANNELLO FAST-GRIP
FAST GRIP PANEL-HOLDING FRAME

SWING TABLET 1 | 1^{plus}

- Serratura con cilindro di sicurezza
- 2 deviatori Block, uno inferiore e uno superiore
- 6 rostri swing
- Limitatore di apertura a traslazione

- *Lock with security cylinder*
- *2 block deviators, lower and upper one*
- *6 fixed swing*
- *Shifting opening-limiting device*

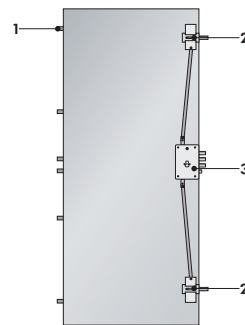

1. n°6 rostri swing
6 fixed swing
2. Deviatore "BLOCK"
"BLOCK" deviator
3. Serratura triplice a cilindro
Triple cylinder lock





Swing Tablet 1 plus con rivestimento Isy 1 Beton Maloja
Swing Tablet 1 plus with Isy 1 panelling, Beton Maloja

SWING

TABLET 3|3^{plus}

- Serratura con doppia mappa Lock Trap System più cilindro inferiore di servizio.
Due sistemi di chiusura indipendenti.
Sistema principale a doppia mappa.
- 2 deviatori Block, uno inferiore e uno superiore
- 6 rostri swing
- Limitatore di apertura a traslazione

- *Lock Trap System double bit lock with lower service cylinder*
Two independent locking systems.
Double bit main system.
- *2 Block deviator, lower and upper*
- *6 fixed swing*
- *Shifting opening-limiting device*

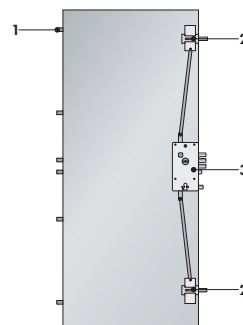

1. n°6 rostri swing
6 fixed swing
2. Deviatore "BLOCK"
"BLOCK" deviator
3. Serratura tripla doppia mappa
+ cilindro inferiore di servizio
Triple double bit lock
+ lower service cylinder

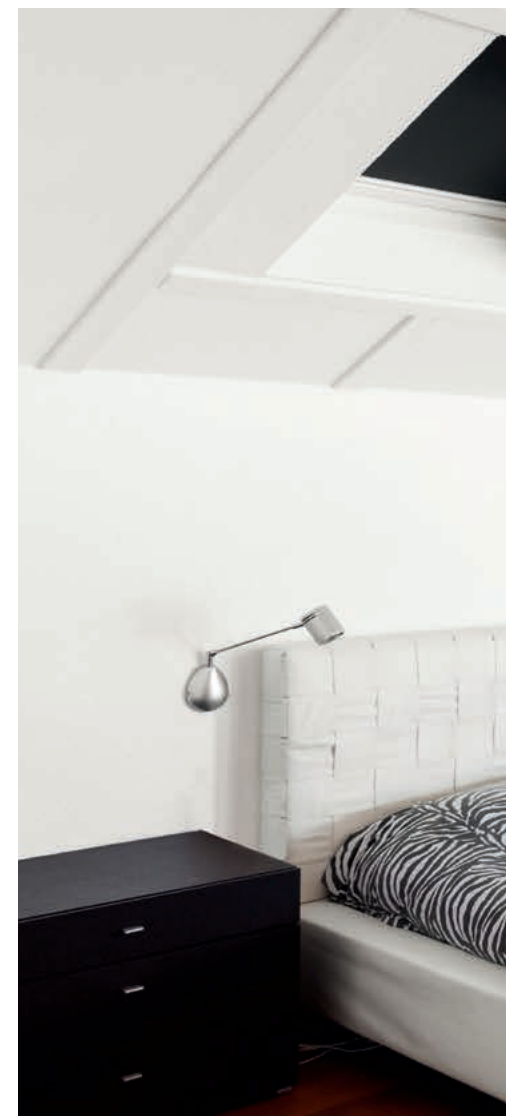



Swing Tablet 3 plus con rivestimento PrintWood modello Music
Swing Tablet 3 plus with PrintWood panel Music model

SWING

TABLET 4 | 4^{plus}

- Serratura con doppia mappa Lock Trap System
- 2 deviatori Block, uno inferiore e uno superiore
- 6 rostri swing
- Limitatore di apertura a traslazione

- *Lock with upper security cylinder and lower service cylinder.*
- *Lock Trap System double bit lock*
- *2 Block deviators, one lower and one upper*
- *6 Fixed swing*
- *Shifting opening-limiting device*

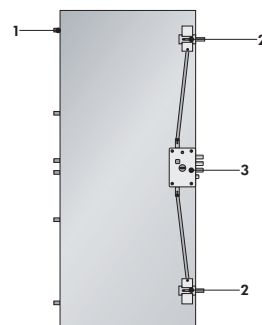

1. n°6 rostri swing
6 fixed swing
2. Deviatore "BLOCK"
"BLOCK" deviator
3. Serratura triplice doppia mappa
Triple double bit lock





Swing Tablet 4 plus con rivestimento Glaks Rosa Colorado lucido
Swing Tablet 4 plus with Glaks Rosa Colorado panelling

SWING

TABLET 8 | 8^{plus}

- Serratura con cilindro superiore di sicurezza e cilindro inferiore di servizio
Due sistemi di chiusura indipendenti.
Sistema principale: cilindro di sicurezza Neos.
- 2 deviatori Block, uno inferiore e uno superiore
- 6 rostri swing
- Limitatore di apertura a traslazione

- *Lock with upper security cylinder and lower service cylinder*
Two independent locking systems.
Main system: Neos security cylinder
- *2 Block deviators, one lower and one upper*
- *6 Fixed swing*
- *Shifting opening-limiting device*

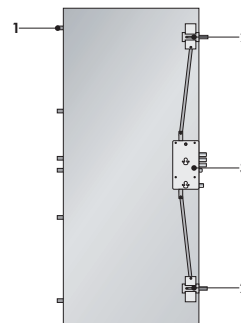

1. n°6 rostri swing
6 fixed swing
2. Deviatore "BLOCK"
"BLOCK" deviator
3. Serratura tripla: cilindro superiore di sicurezza + cilindro inferiore di servizio
Triple lock: upper security cylinder + lower service cylinder

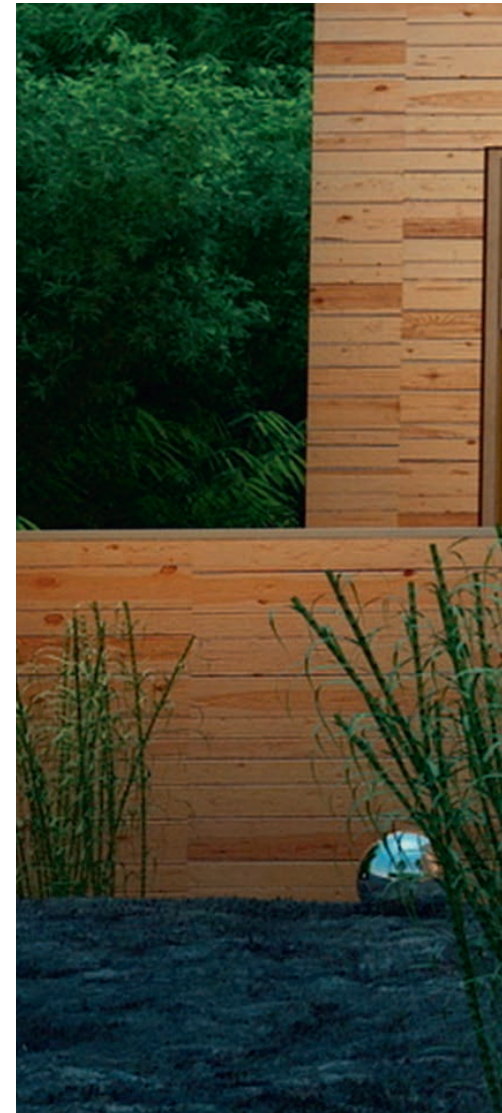



Swing Tablet 8 con rivestimento in Alluminio Serie P Darling
Swing Tablet 8 with Darling Aluminum Series P panelling

La sicurezza swing
Security by Swing



Primo piano sulla protezione

Protection first

Swing ha un'anima d'acciaio. La scocca, al cui interno sono fissati speciali rinforzi verticali, consente più resistenza e rigidità all'intera struttura. I sei rostri Swing, lungo il lato delle cerniere, a battente chiuso s'inseriscono nelle cavità corrispondenti sul telaio, in modo da impedire lo scardinamento. Il deviatore Block sul lato inferiore e sul lato superiore, comandato dalla serratura, si inserisce nel telaio e ancora e blocca saldamente la porta. Il cilindro è avvolto da una boccola d'acciaio, il Defender, che protegge il lato esterno della serratura, aumentando la resistenza da utensili da scasso. La lamina parafredddo a filo pavimento, particolare indispensabile per una porta di sicurezza, protegge da spifferi d'aria e lame di luce, rientrando automaticamente all'apertura della porta.

Swing comes with a steel core. The body with special vertical reinforcements fixed inside allows more strength and sturdiness to the whole structure.

The six fixed grips, along the hinged side, with the leaf closed inserts in the corresponding housings on the frame, so as to prevent unhinging. The Block deviator on the bottom and upper side, controlled by the lock, fits in the frame and anchors and firmly blocks the door. A steel bushing, the Defender, surrounds the cylinder thus protecting the outer side of the lock, increasing resistance to break-in tools. The flush with the floor cold excluding sill, indispensable detail for a security door, protects from drafts of air and blades of light, returning automatically when the door is opened.



ROSTRO SWING
SWING GRIP

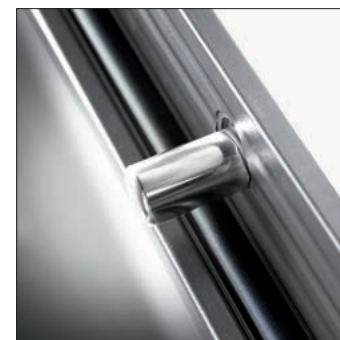

DEVIATORE BLOCK
BLOCK DEVIATOR



DEFENDER
DEFENDER



LAMINA PARAFREDDO
COLD EXCLUDING SILL

I sistemi di chiusura

Locking systems

SERRATURE A DOPPIA MAPPA
LOCKS DOUBLE BIT

LOCK

trap system

Frutto della costante ricerca Dierre, Lock Trap System è la sintesi perfetta di tecnologia, qualità e innovazione. Come funziona? In caso di tentata effrazione, il sistema interviene e blocca la serratura, ma, una volta estratto lo strumento di manomissione, libera il meccanismo e consente la normale apertura. Lock Trap System ha superato le severe prove di antimanipolazione previste dal marchio A2P* riconosciuto dal prestigioso istituto di prevenzione e controllo dei rischi CNPP.

Thanks to constant research, Dierre's Lock Trap System is the perfect synthesis of technology, quality and innovation. How does it work? In case of

burglary attempt, the system is activated and blocks the latch, but, once the burglary tool has been extracted, it is automatically disabled, allowing to normally open the door. Lock Trap System passed strict anti-manipulation tests required by the A2P brand recognised by the renowned CNPP Risk Control and Prevention Institute.*

Anche Lock Trap System utilizza il brevetto MIA che, in caso di furto o smarrimento delle chiavi, consente la rapida e semplice sostituzione del blocchetto centrale.

Also Lock Trap System employs MIA patented technology that, in case of theft or loss, allows to replace the central block quickly.



Chiave a doppia mappa
Double bit key

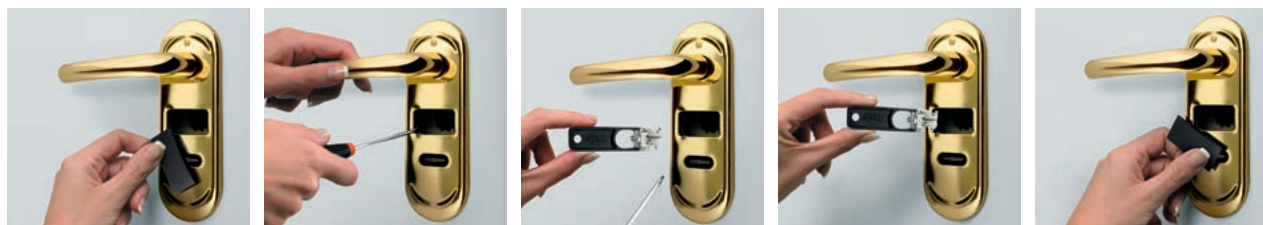

Rimuovere la copertura di plastica.

Remove the plastic cover.

Con un cacciavite svitare le due viti che fissano il blocchetto.

Unscrew with a screwdriver the two screws that fix the block.

Aprire l'astuccio contenente il blocchetto personalizzato e le chiavi in dotazione. Con l'apposito estrattore che trovate nella scatola, togliere il blocchetto.

Open the pack containing the personalized block and the provided keys. Remove the block with the extractor that you'll find in the box.

Inserire il nuovo blocchetto e riavvitare le due viti di fissaggio.

Insert the new block and screw back on the two fixing screws.

Richiudere la copertura di plastica.

Close the plastic cover.

SERRATURE PER CILINDRO
LOCKS FOR CYLINDER

LOCK

blocking system

Lock Blocking System permette di bloccare la serratura qualora si cercasse di strappare il cilindro con la tecnica distruttiva volgarmente chiamata "attacco del tubo".

Lock Blocking System allows to block the lock in the event of an attempt of wrenching the cylinder with the technique normally called "snap attack".

Cilindro Neos *
Neos Cylinder



Extra **

NEW POWER

- Sistema anti-manipolazione brevettato
- Meccanismo del cilindro anti-bumping
- Sbozzo di chiave protetto con accoppiamento rotondo brevettato
- Duplicazione chiave protetta
- 2 volte più resistente alla rottura in mezzeria rispetto ad un cilindro in ottone
- Cilindro modulare
- *Patented anti-manipulation system*
- *Anti-bumping cylinder mechanism*
- *Key blanks protected with rounded patented coupling*
- *Key duplication protected and controlled*
- *2 times more resistant to halfway breakage compared to a brass cylinder*
- *Modular Cylinder*



* di serie / standard

** a richiesta / on request



Swing tablet 1 plus con rivestimento liscio laccato bianco ral 9010
Swing tablet 1 plus with smooth panelling lacquered ral 9010

A large, light gray, stylized number '1' graphic that spans the left and center of the page. It has a thick, blocky appearance with a slight shadow effect.

Lo stile swing

Safety by Swing

Anche Swing Tablet, come ogni porta Dierre, interpreta il concetto di porta di sicurezza con grande attenzione all'espressione formale e ampia libertà di personalizzazione. Design, materiali di rivestimento, finiture, dettagli, colori. Ogni elemento estetico contribuisce a fare di Tablet una porta bella, oltre che sicura, intelligente, performante.

Swing Tablet also, as all Dierre doors, interprets the concept of security door with great care to formal expression and the most ample freedom of customization. Design, panelling materials, finishes, details and colors. Each aesthetic item contributes to make Tablet a beautiful looking door in addition of being secure, smart and high-performing.

SWING
TABLET 1|1^{plus}

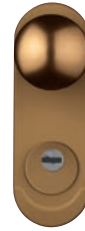

lato interno
internal side

lato esterno
external side

SWING
TABLET 4|4^{plus}



lato interno
internal side

lato esterno
external side

Maniglia
Handles

New Creta

Di serie, bronzo.
A richiesta, argento
e simil ottone lucido.

New Creta

Bronze as standard.
On request, silver
and polished brass-like.

SWING
TABLET 3|3^{plus}

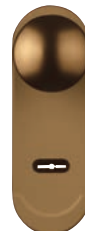

lato interno
internal side

lato esterno
external side

SWING
TABLET 8|8^{plus}



lato interno
internal side

lato esterno
external side

Maniglia Extra*

Extra handles

Amsterdam

Disponibile in cromo satinato e cromo lucido.

Amsterdam

Available in satin and polished chrome.

SWING TABLET 1 | 1^{plus}



lato interno
internal side

lato esterno
external side

SWING TABLET 8 | 8^{plus}



lato interno
internal side

lato esterno
external side

* Per utilizzare questa maniglia è necessario sostituire il cilindro di serie con il cilindro New Power.

These handles can be used having previously replaced the standard cylinder with the New Power cylinder

SWING TABLET 1 | 1^{plus}

Dallas

Disponibile in cromo satinato,
cromo lucido, argento
e grigio antracite satinato.

Dallas

Available in satin and polished
chrome, silver and anthracite
gray satin.



lato interno
internal side

lato esterno
external side

SWING TABLET 8 | 8^{plus}



lato interno
internal side

lato esterno
external side

RIVESTIMENTI PER PORTE DI SICUREZZA

SECURITY DOOR PANNELLING

La più ricca collezione di rivestimenti per porte di sicurezza mai realizzata. Un panorama di proposte che risponde a qualsiasi desiderio, progetto e necessità abitativa. Richiedi il catalogo Rivestimenti per scoprire tutti i modelli disponibili.

The richest collection ever realized of panelling for security doors. A range of proposals to respond to any desire, project and furnishing requirement. Ask for the Panelling catalogue to discover all the available models.

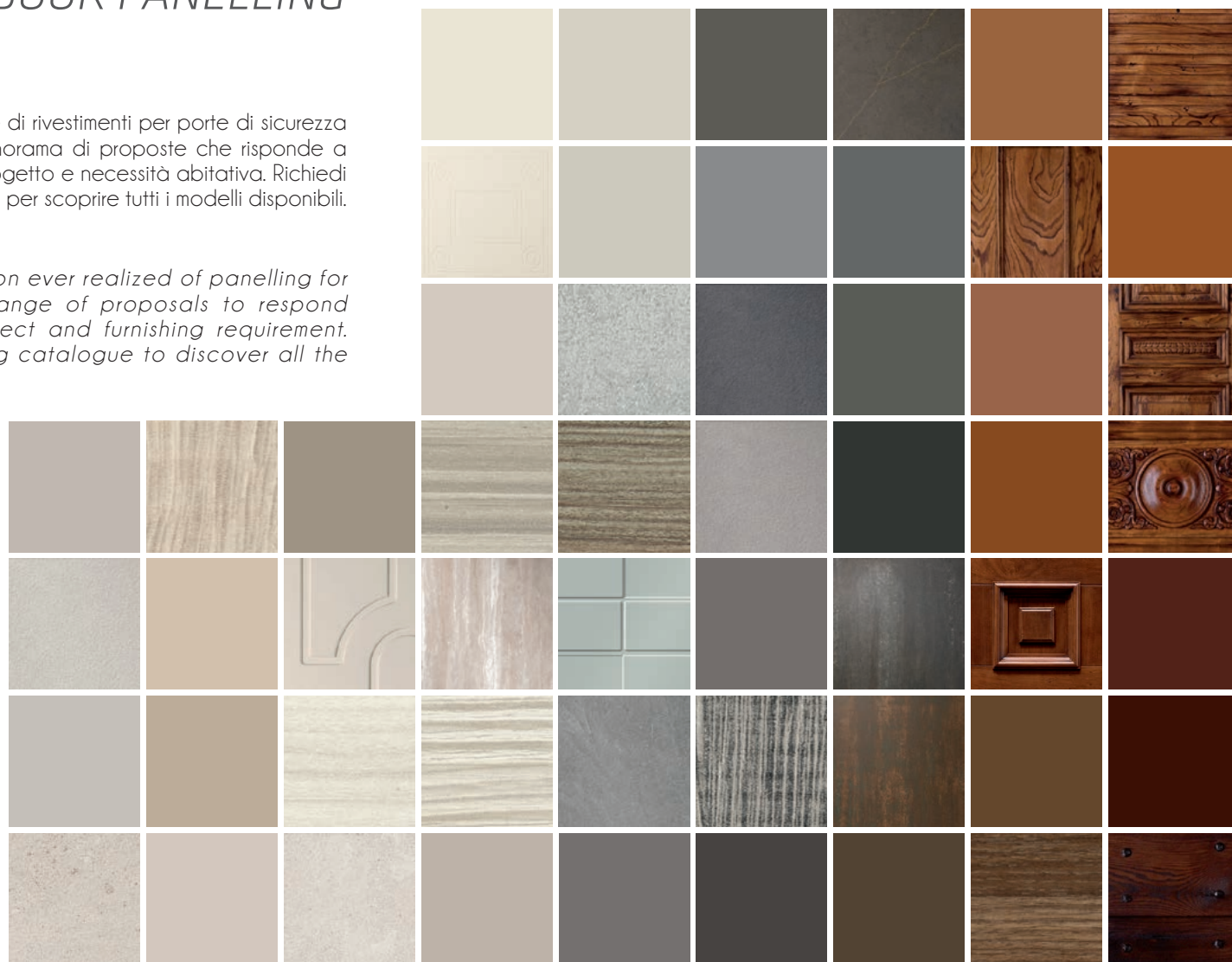

PRINT WOOD

IDENTITY PANELLING

Con il nuovo pannello di rivestimento Printwood personalizzi la tua porta blindata in modo originale e distintivo, scegliendo fra le suggestive immagini suggerite da Dierre oppure con una foto realizzata e proposta da te.

With the new Printwood panelling you can customize your security door in an original and distinctive way, choosing amongst the inspiring pictures Dierre suggests or with a photo you took and proposed.



Tavola sinottica

Tavola sinottica

SWING TABLET

Modelli models	Tipo di Serratura Lock Type	Carenatura a grappa Clip-on trim	Cornice FastGrip FastGrip cornice	Trasmittanza termica U value	Isolamento acustico Acoustic insulation	Classe antieffrazione Burglarproof class	Deviatore Deviator
Swing vers. Tablet 1	cilindro di sicurezza Security cylinder	X		1,3	40	3	2 block
Swing vers. Tablet 1 plus	cilindro di sicurezza Security cylinder		X	1,3	40	3	2 block
Swing vers. Tablet 3	doppia mappa Lock Trap System + cilindro di servizio Double bitted Lock Trap System + Service cylinder	X		1,3	40	3	2 block
Swing vers. Tablet 3 plus	doppia mappa Lock Trap System + cilindro di servizio Double bitted Lock Trap System + Service cylinder		X	1,3	40	3	2 block
Swing vers. Tablet 4	doppia mappa Lock Trap System Double bitted Lock Trap System	X		1,3	40	3	2 block
Swing vers. Tablet 4 plus	doppia mappa Lock Trap System Double bitted Lock Trap System		X	1,3	40	3	2 block
Swing vers. Tablet 8	cilindro superiore di sicurezza + cilindro inferiore di servizio Upper security cylinder + lower service cylinder	X		1,3	40	3	2 block
Swing vers. Tablet 8 plus	cilindro superiore di sicurezza + cilindro inferiore di servizio Upper security cylinder + lower service cylinder		X	1,3	40	3	2 block

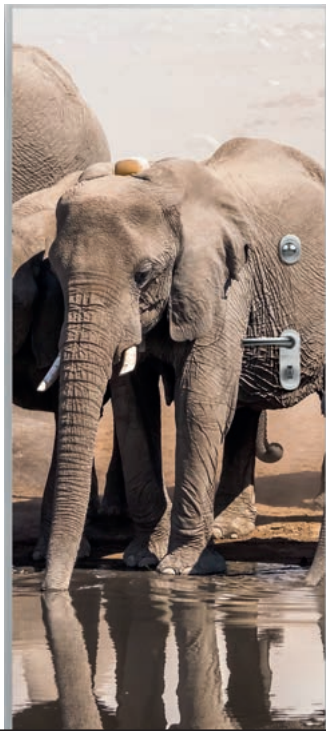
Rostri Swing Swing grips	Limitatore di apertura Opening limiting device		Fermaporta antitorsione telaio Frame twist-prevention door stop	Versione Version		Dimensioni standard Standard Size	Dimensioni fuori misura Oversize	Maniglia New Creta New Creta Handles	Maniglia Diere Diere Handles	Maniglia Extra Extra Handles	
	Traslazione Translation	Rotazione (Open View) Rotation (Open View)		1 anta 1 leaf	doppio battente Double leaf					Amsterdam	Dallas
6 rostri Swing 6 Swing grips	X		X	X		X		X		X	X
6 rostri Swing 6 Swing grips	X		X	X		X		X		X	X
6 rostri Swing 6 Swing grips	X		X	X		X		X			
6 rostri Swing 6 Swing grips	X		X	X		X		X			
6 rostri Swing 6 Swing grips	X		X	X		X		X			
6 rostri Swing 6 Swing grips	X		X	X		X		X			
6 rostri Swing 6 Swing grips	X		X	X		X		X		X	X
6 rostri Swing 6 Swing grips	X		X	X		X		X		X	X

Schede tecniche

Technical sheets

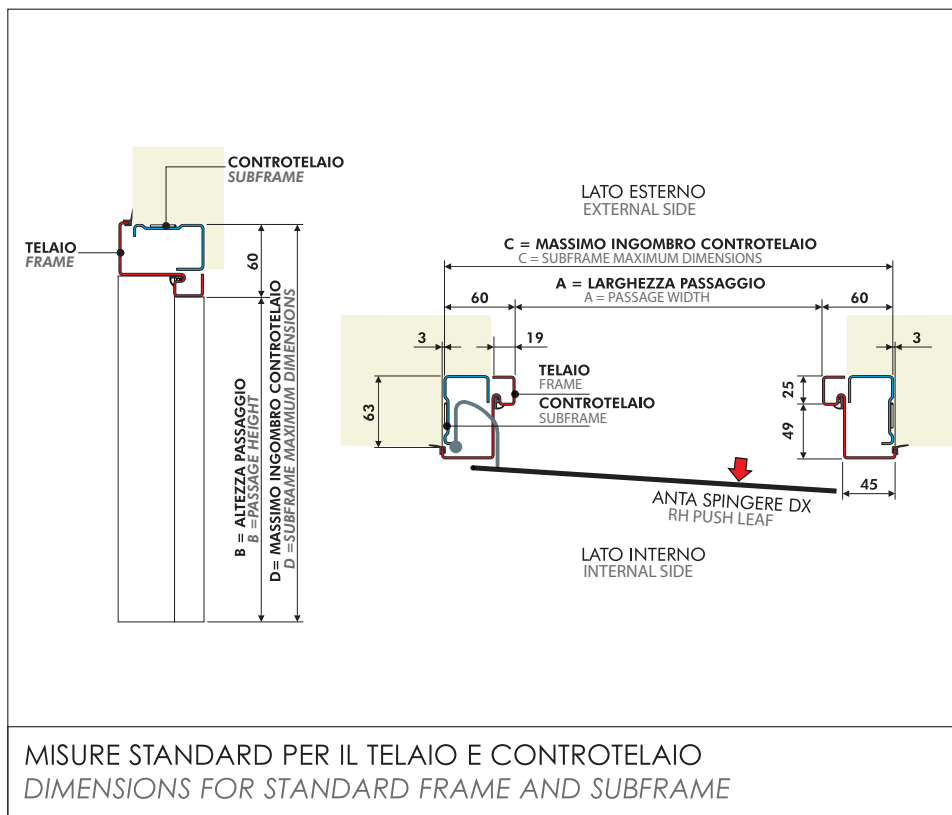

MISURE STANDARD PER IL TELAIO E CONTROTELAIO
DIMENSIONS FOR STANDARD FRAME AND SUBFRAME

MISURE PER IL TELAIO E C. T. STANDARD			
A	B	C	D
900	2100	1020	2160
850	2100	970	2160
800	2100	920	2160
900	2200	1020	2260
850	2200	970	2260
800	2200	920	2260

COME RICAIVARE LE MISURE		ES
LARGHEZZA VANO MURO		1030
GIOCO D'USO		10
60		60
60		60
A LARGHEZZA PASSAGGIO = 900		
ALTEZZA VANO MURO		2170
GIOCO D'USO		10
60		60
B ALTEZZA PASSAGGIO = 2100		
PER ORDINI FORNIRE DIMENSIONI A B DISPONIBILI ANCHE FUORI MISURA		

DIMENSIONS FOR STANDARD FRAME AND STANDARD SUBFRAME			
A	B	C	D
900	2100	1020	2160
850	2100	970	2160
800	2100	920	2160
900	2200	1020	2260
850	2200	970	2260
800	2200	920	2260

HOW TO OBTAIN THE DIMENSIONS EX.	
WALL OPENING WIDTH	1030
USE PLAY	10
60	60
60	60
A PASSAGE WIDTH = 900	
WALL OPENING HEIGHT	2170
USE PLAY	10
60	60
B PASSAGE HEIGHT = 2100	
GIVE A B DIMENSIONS WHEN ORDERING AVAILABLE IN NON STANDARD SIZES	

Disegni tecnici

Technical drawings

Nei disegni tecnici presentati, sono riportati tutti i dati relativi agli ingombri delle porte Tablet door.
The technical drawings include all the details relating to the dimensions of the Tablet door.

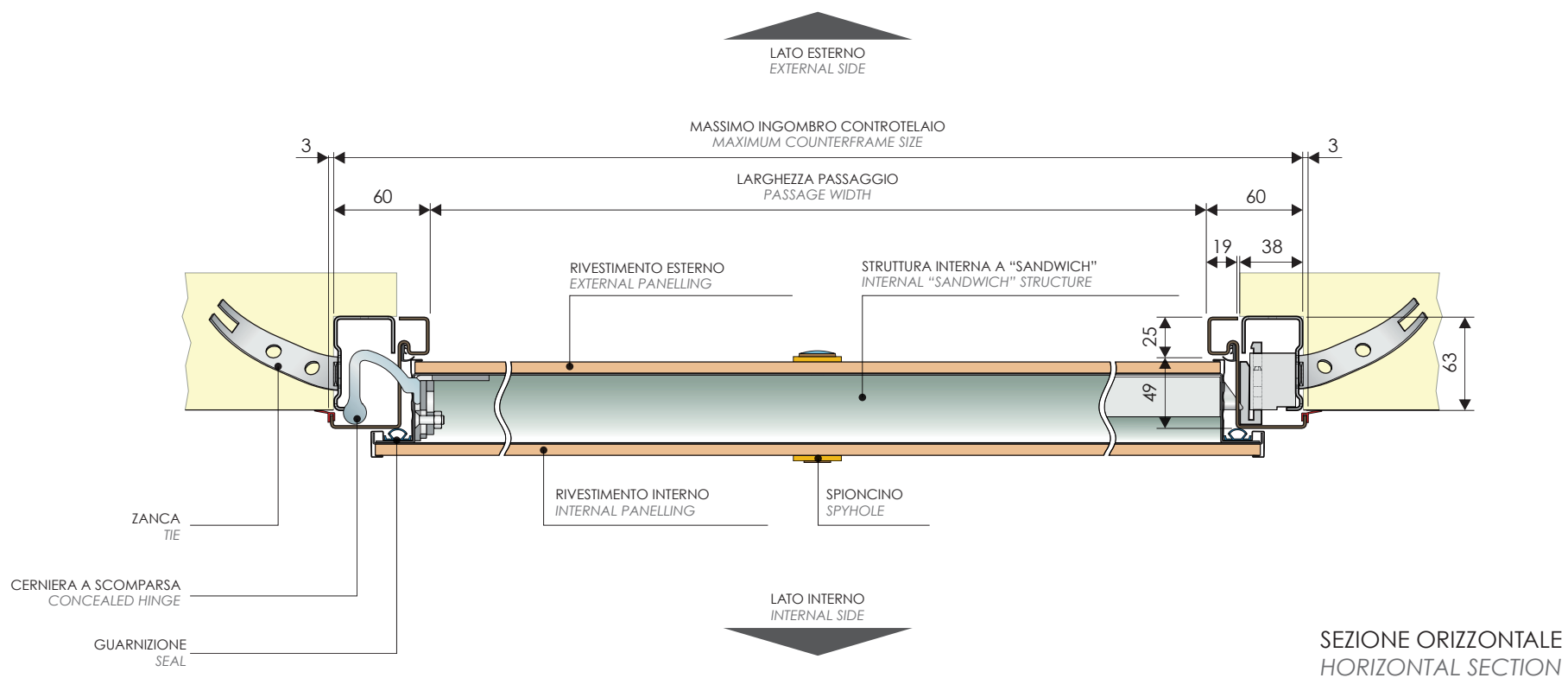

SEZIONE VERTICALE
VERTICAL SECTION

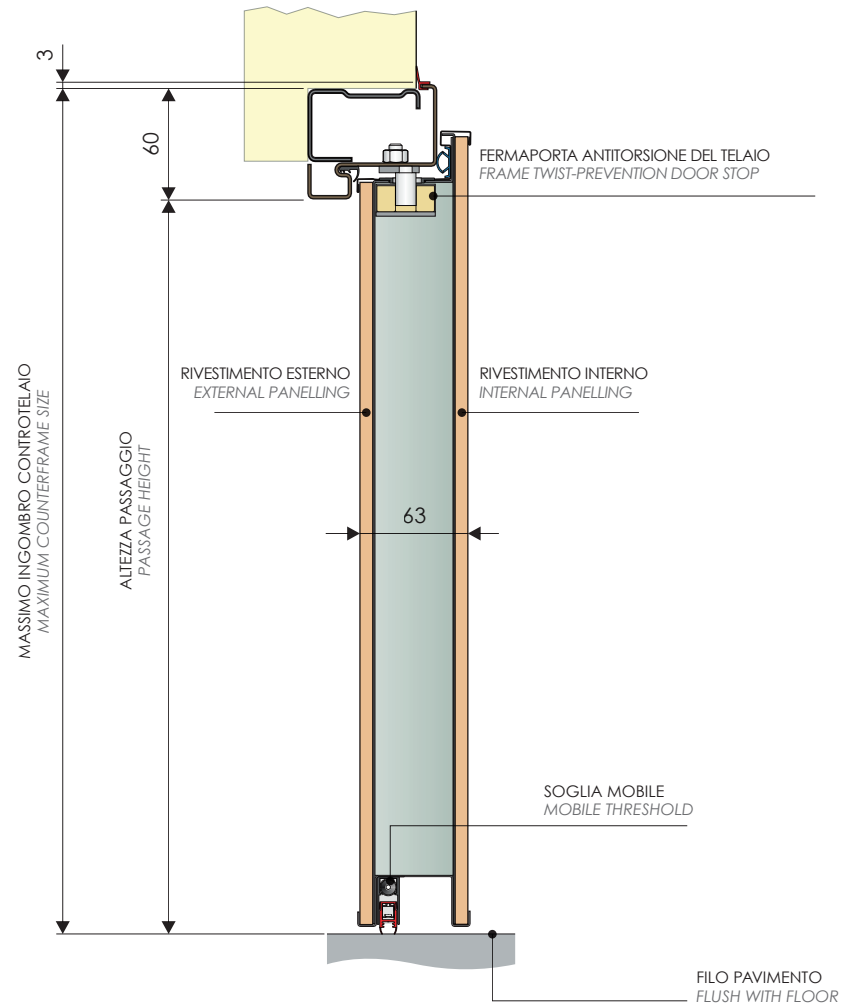

SEZIONE ORIZZONTALE
HORIZONTAL SECTION

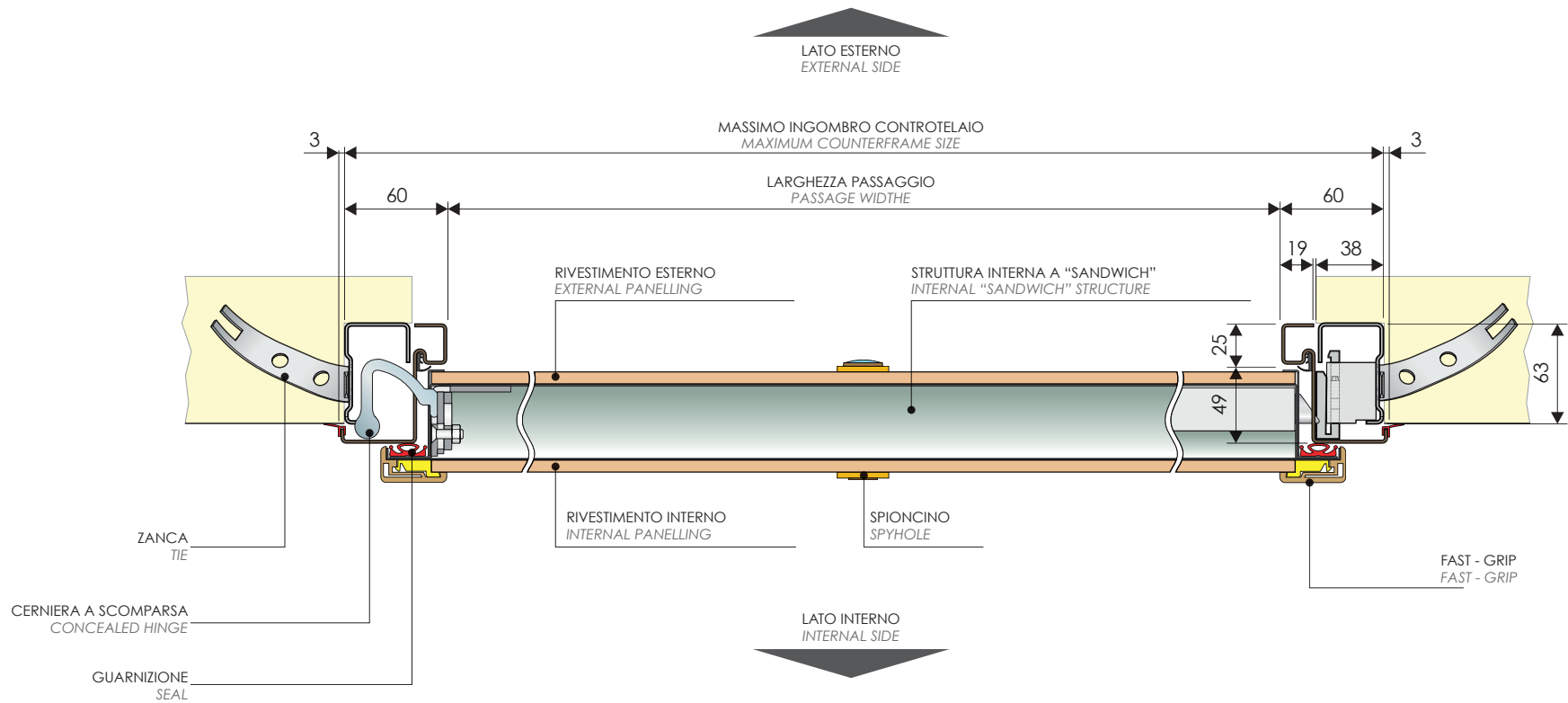

SEZIONE VERTICALE
VERTICAL SECTION

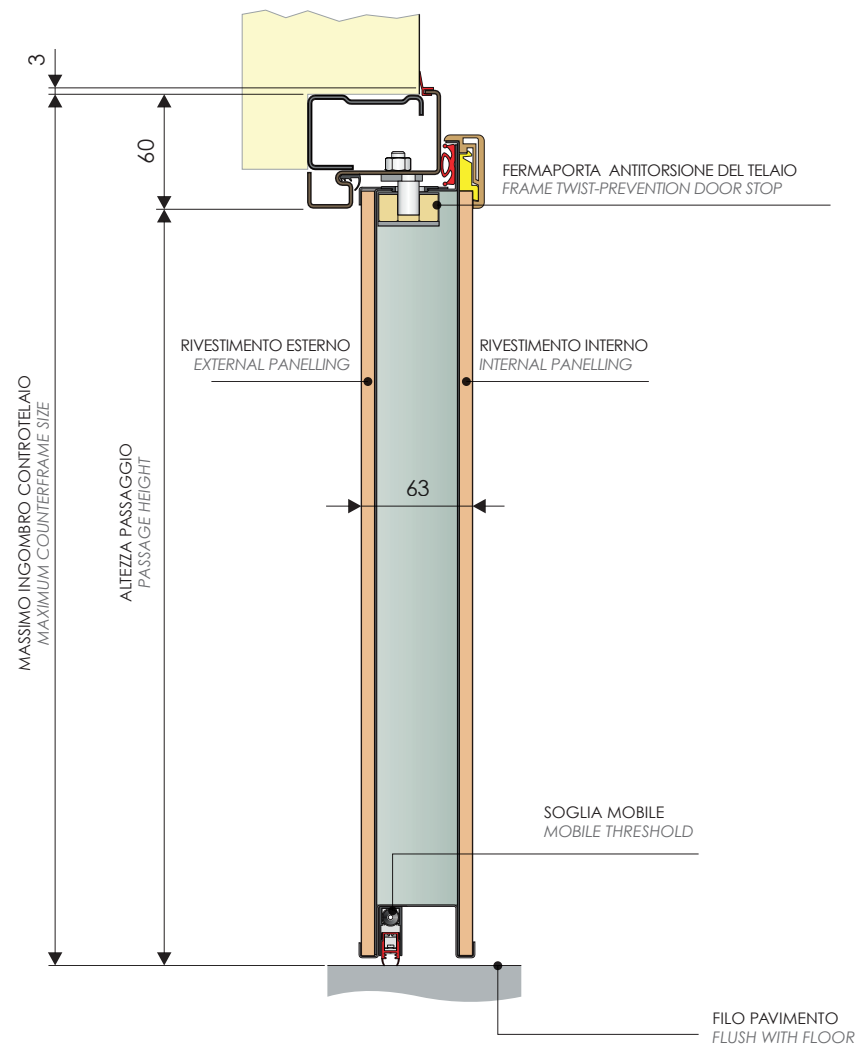

FINITURA MARMO
MARBLE FINISH

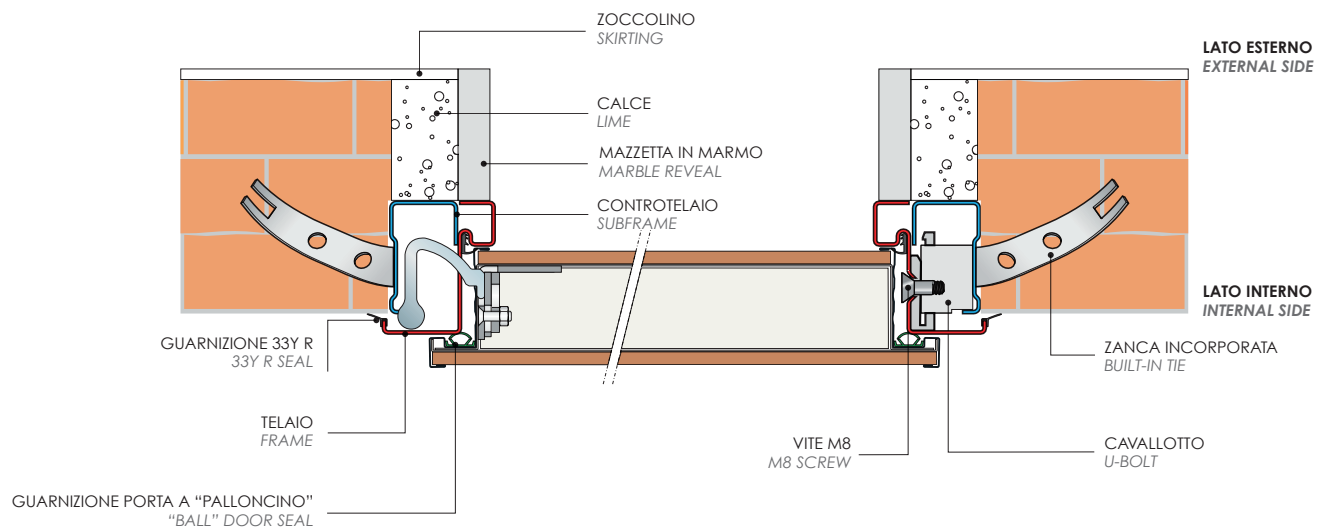

FINITURA INTONACO
PLASTER FINISH

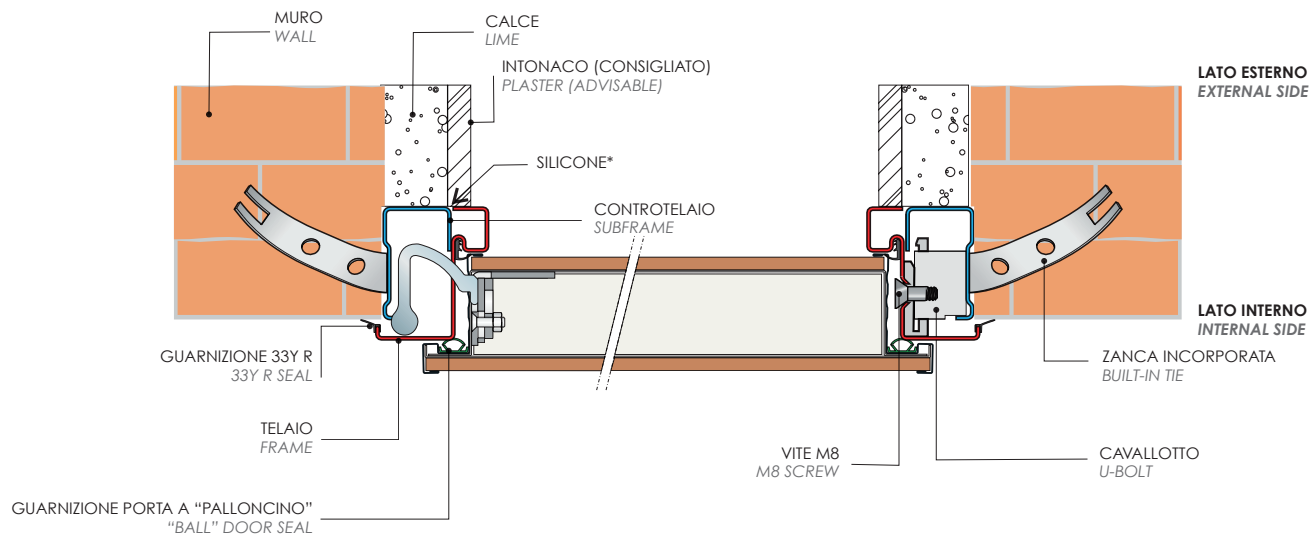

FINITURA PER INTONACO CON SGUINCO
PLASTER FINISH WITH SPLAY

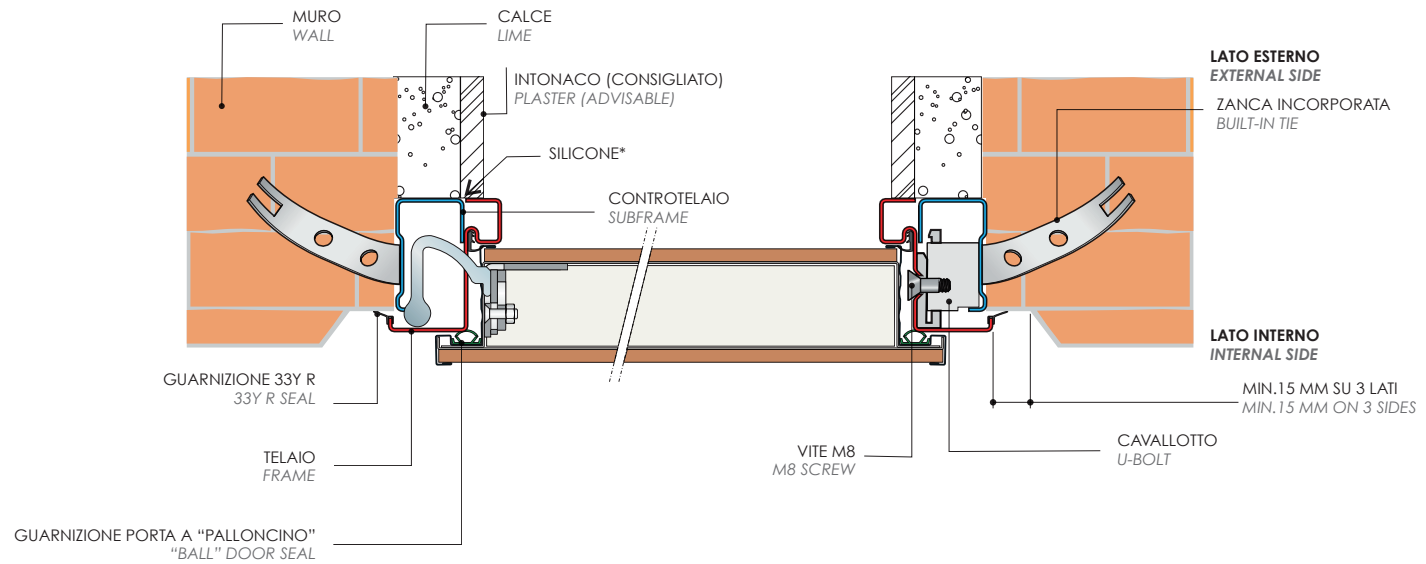

*Qualora si sceglia di non intonacare oltre la giunzione telaio/controtelaio, è necessario sigillare con silicone il giunto, seguendo tutto il perimetro del telaio lato esterno.
* If you choose not to plaster over the frame/subframe joint, it is necessary to silicone the joint, over the whole perimeter of the frame outer side.

FINITURA MARMO - TELAIO CON GUARNIZIONE INTEGRATA
MARBLE FINISH - FRAME WITH INTEGRATED SEAL

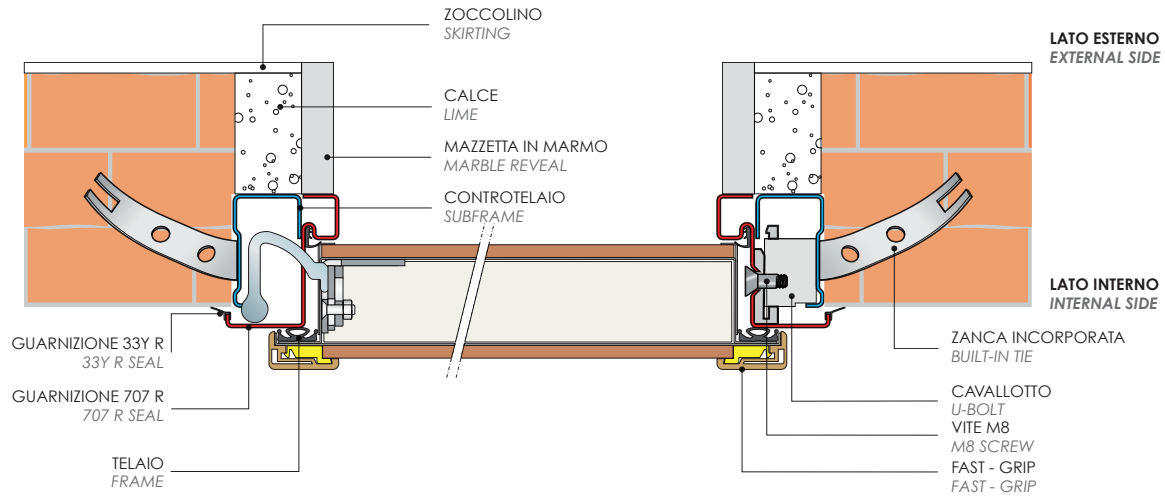

FINITURA INTONACO - TELAIO CON GUARNIZIONE INTEGRATA
PLASTER FINISH - FRAME WITH INTEGRATED SEAL

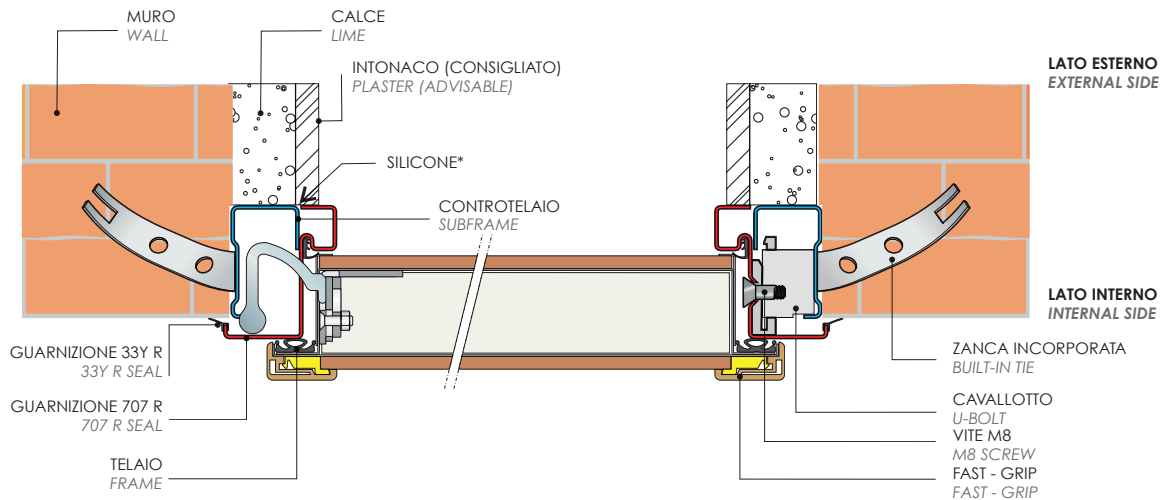

FINITURA PER INTONACO CON SGUINCIO - TELAIO CON GUARNIZIONE INTEGRATA
 PLASTER FINISH WITH SPLAY - FRAME WITH INTEGRATED SEAL

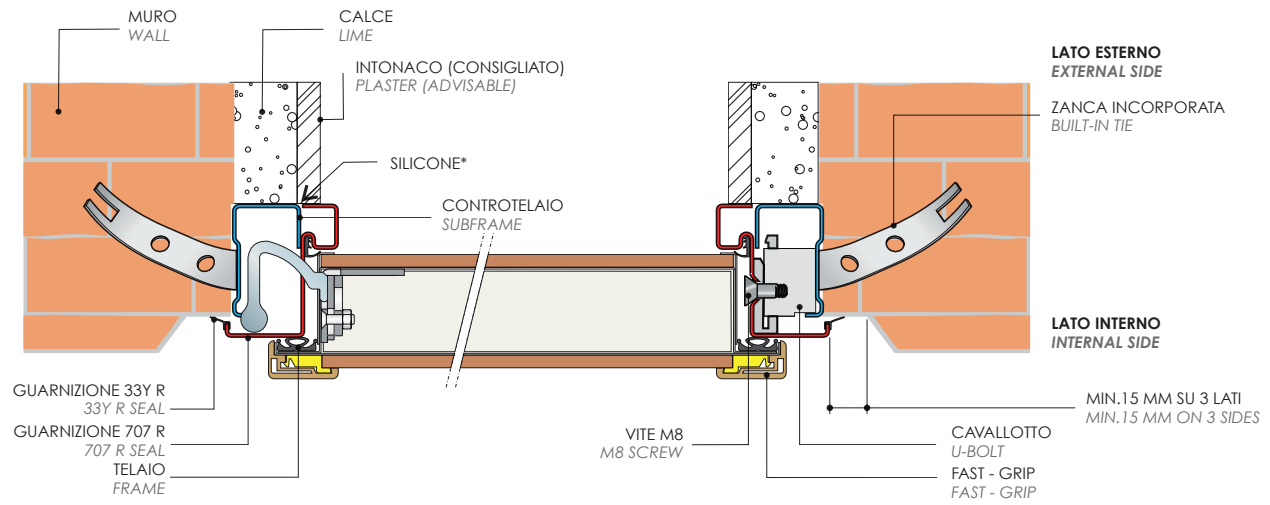

*Qualora si sceglia di non intonacare oltre la giunzione telaio/controtelaio, è necessario sigillare con silicone il giunto, seguendo tutto il perimetro del telaio lato esterno.
 * If you choose not to plaster over the frame/subframe joint, it is necessary to silicone the joint, over the whole perimeter of the frame outer side.

